

MONTAGEANLEITUNG SEILSPANN-SONNENSEGEL

Seilspanntechnik Exklusiv

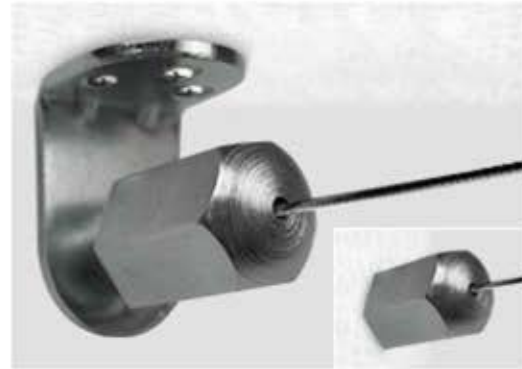

Zubehör

1 x Metallkappe

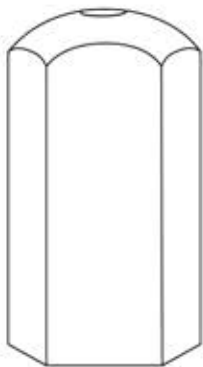

1 x Gewindeeinsatz

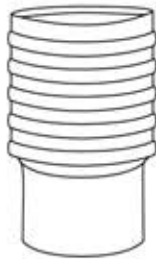

1 x Winkel

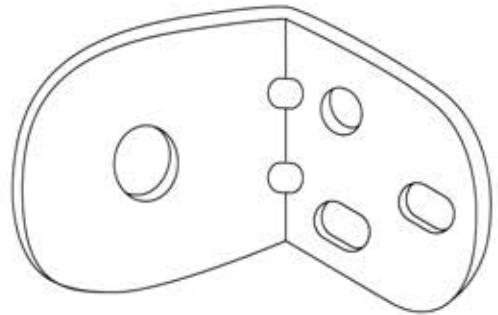

1 x Gummi



1 x Schraube kurz



4 x Dübel

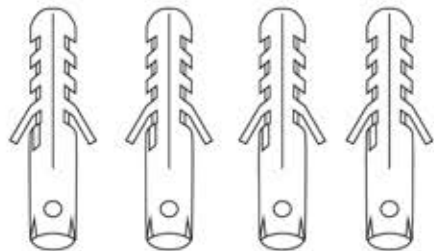

3 x Schrauben

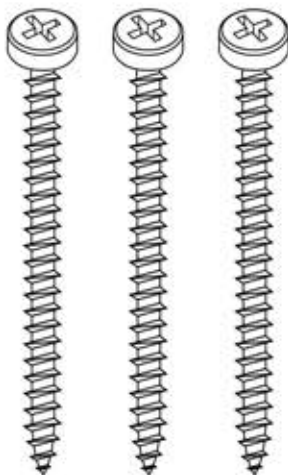

1 x Gewindestab



1 x Metalleinsatz mit
2 x Feststellschrauben

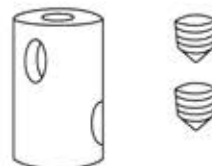

10m Edelstahlseil



MONTAGEANLEITUNG SEILSPANN-SONNENSEGEL

Seilspanntechnik Exklusiv

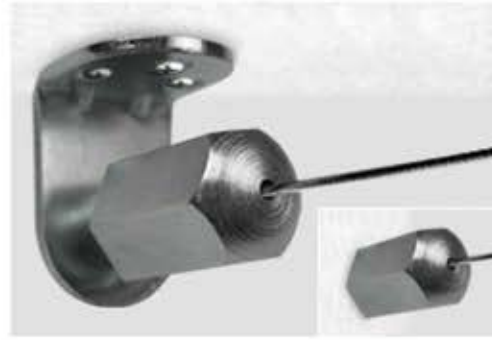

Befestigung seitlich oben

Gewindeschraube und Gummi einsetzen

Schrauben fixieren

1

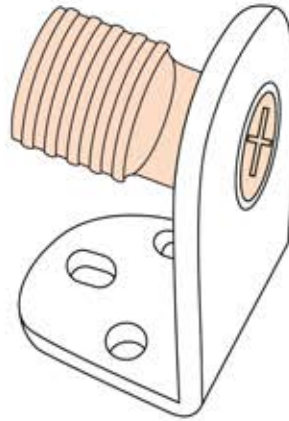
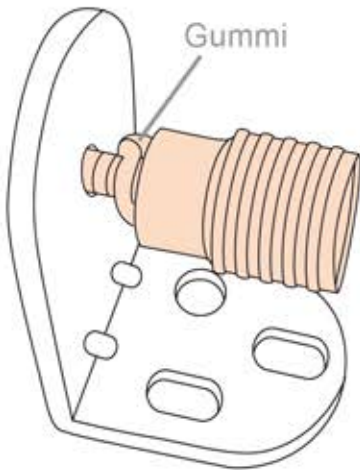

2

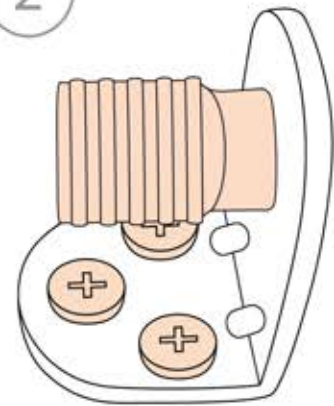

Fixieren des Drahtes mittels
Inbusschlüssel

Fixieren des Drahtes

3

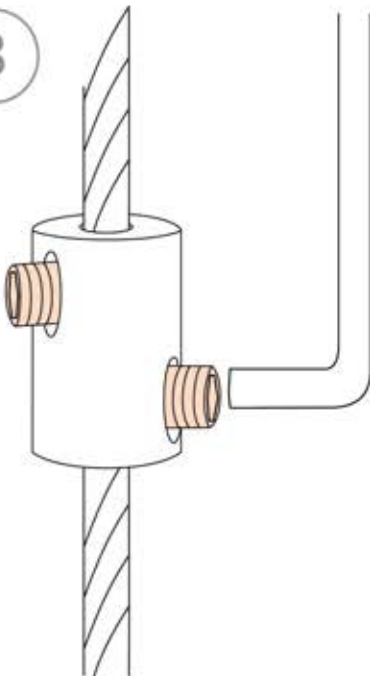

4

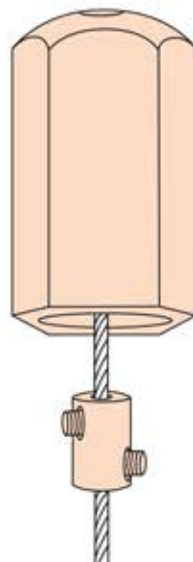

5

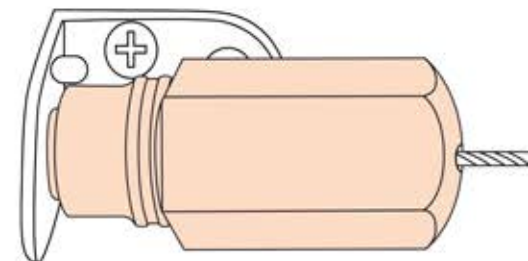

MONTAGEANLEITUNG SEILSPANN-SONNENSEGEL

Seilspanntechnik Exklusiv

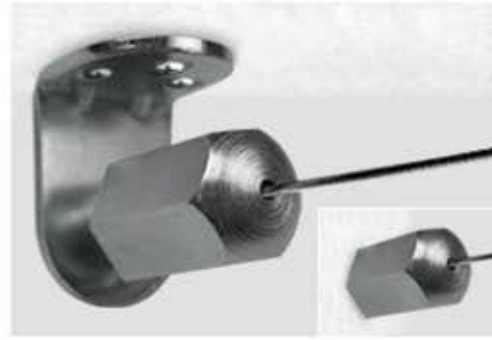

Befestigung an der Stirnseite

Gewindeinsatz mittels Schraube befestigen

Metallzylinder anbringen

1 seitlich

frontal

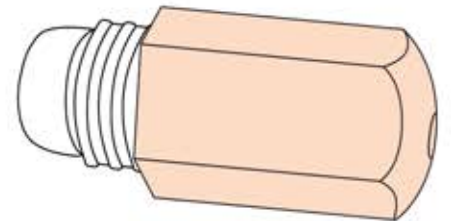
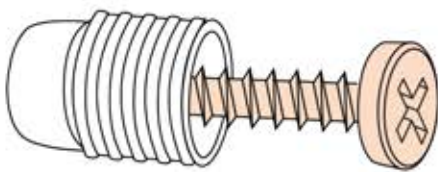

Fixieren des Drahtes mittels Inbusschlüssel

Fixieren des Drahtes

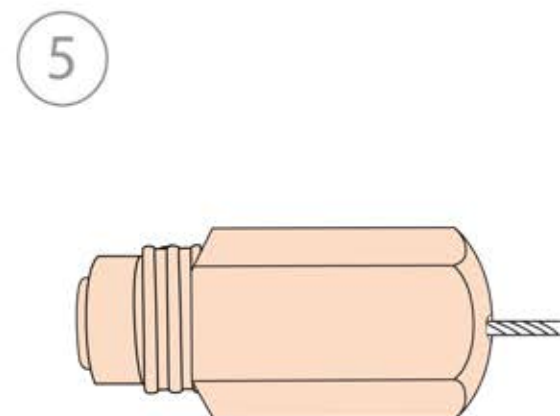
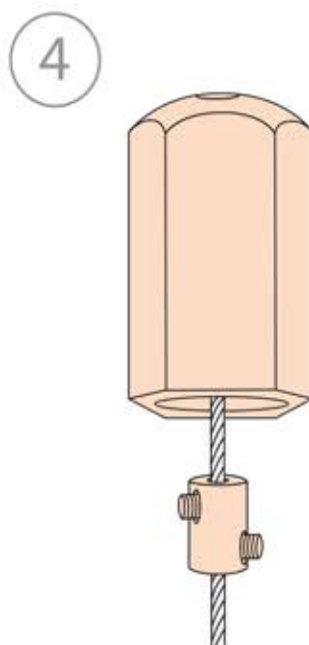
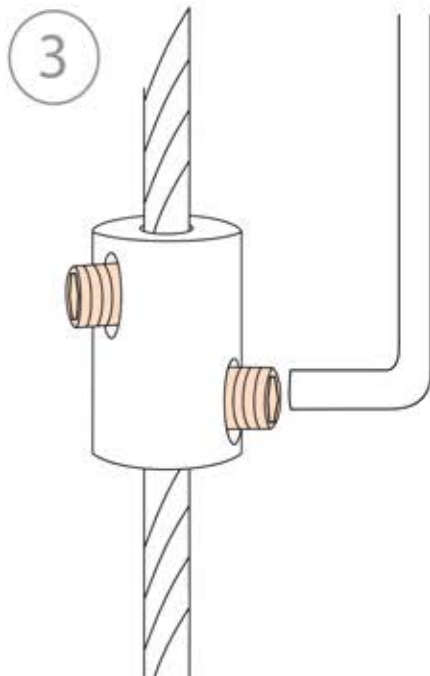

MONTAGEANLEITUNG SEILSPANN-SONNENSEGEL

Seilspanntechnik Exklusiv

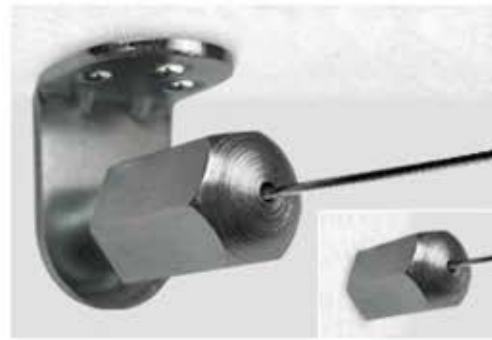

Befestigung an der Stirnseite

optional
Befestigung mittels Gewindestabes

1

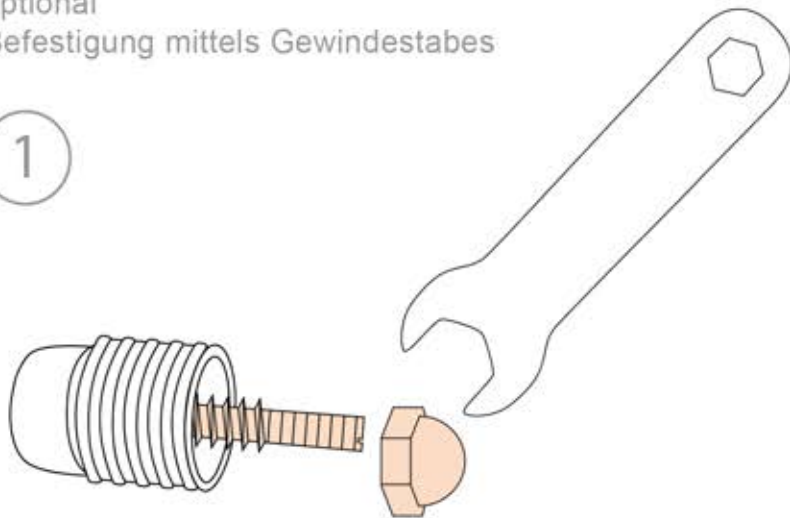

Metallzylinder anbringen

2

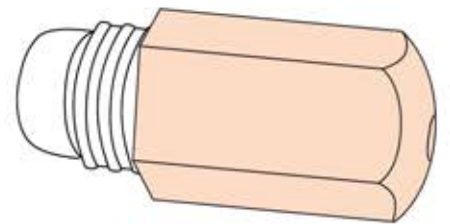

Fixieren des Drahtes mittels
Inbusschlüssel

3

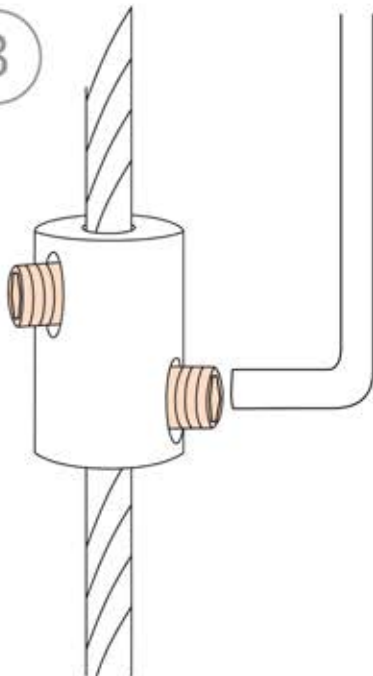

Fixieren des Drahtes

4

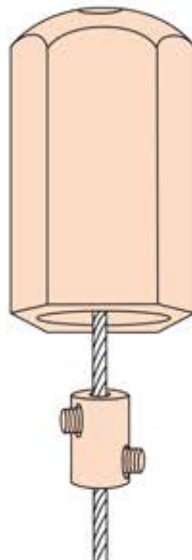

5

